

MODERNA-EQONA

ÇOCUK KORUMALI TOPRAKLI PRİZ KULLANIM KILAVUZU / USER'S MANUAL FOR CHILD PROTECTED GROUNDED SOCKET

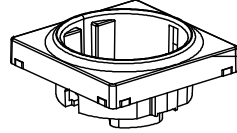

Göbek Vidası / Central Plate Screw



Göbek / Central Plate

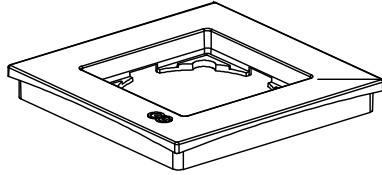

Çerçeve / Frame

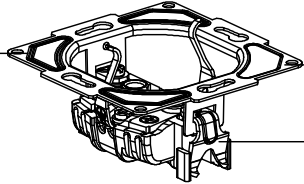

Modül / Module

Şase / Chassis

Tırnak / Claw

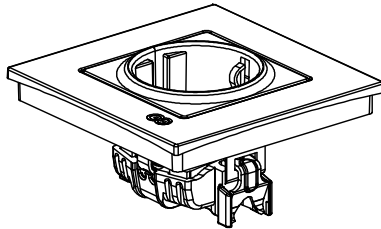

Ürün Boyutları / Product Dimensions

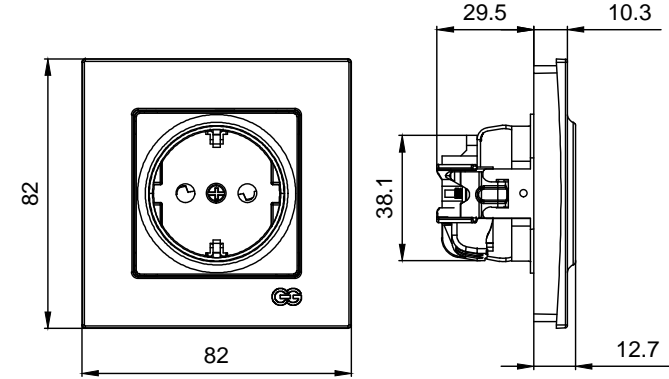

Bağlantı Şeması / Wiring Diagram

- 16A,250V~
- İki kutuplu, topraklamalı
- Vidalı ve klipsli bağlantı
- 16A, 250V~
- 2 Poles, grounded contact
- With screw or clips

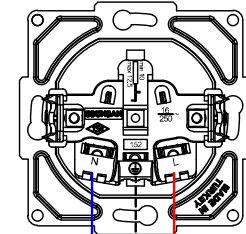

Devre Şeması / Circuit Diagram

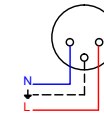

Ürün Montajı / Product Assembly

- Kablo bağlantıları bağlantı şemasına göre yapılır.
Cable connections are made according to the wiring diagram.
- Modül montaj yapılacak kasa içerisine yerleştirilip ve tırnak vidaları ile sıkıştırılarak sabitlenir.
The module is inserted into the enclosure and fixed by tightening with claw screws.
- Göbek çerçeveye takılır.
The central plate is assembled to frame.
- Çerçeve şasenin üzerine konumlandırılır ve göbek vidası ile sıkılarak montaj tamamlanır.
The frame is placed on the chassis and the assembly is completed by screwing the hub screw.

GUNSAN