

## FANTASY-VİSAGE

### ÇOCUK KORUMALI UPS PRİZ KULLANIM KILAVUZU / USER'S MANUAL FOR UPS CHILD PROTECTED SOCKET

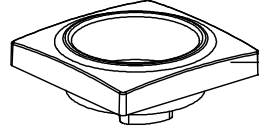

Göbek Vidası / Central Plate Screw



Göbek / Central Plate

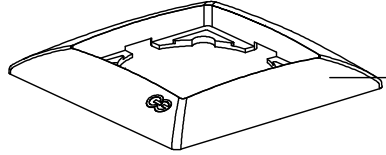

Çerçeve / Frame



Şase / Chassis

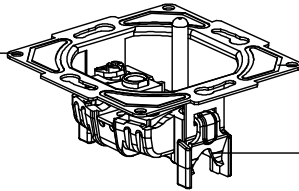

Modül / Module

Tırnak / Claw

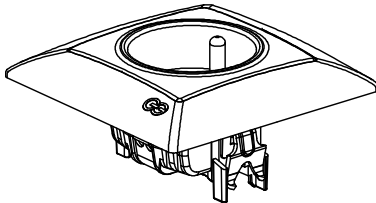

### Ürün Boyutları / Product Dimensions

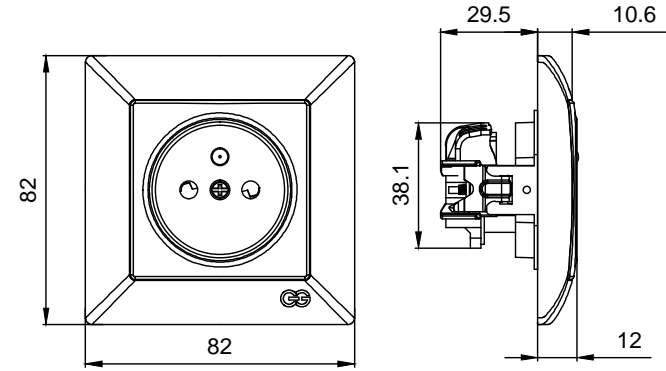

### Bağlantı Şeması / Wiring Diagram

- 16A,250V~
- İki kutuplu, Ups lama
- Vidalı ve klipsli bağlantı
- 16A,250V~
- 2 Poles, Ups
- With screw or clips

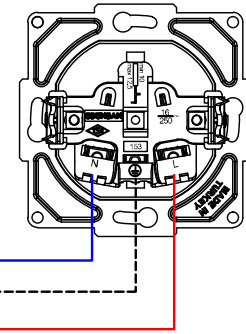

### Devre Şeması / Circuit Diagram

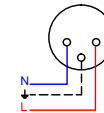

### Ürün Montajı / Product Assembly

- Kablo bağlantıları bağlantı şemasına göre yapılır.  
Cable connections are made according to the wiring diagram.
- Modül montaj yapılacak kasa içerisine yerleştirilip ve tırnak vidaları ile sıkıştırılarak sabitlenir.  
The module is inserted into the enclosure and fixed by tightening with claw screws.
- Göbek çerçeveye takılır.  
The central plate is assembled to frame.
- Çerçeve şasenin üzerine konumlandırılır ve göbek vidası ile sıkılarak montaj tamamlanır.  
The frame is placed on the chassis and the assembly is completed by screwing the hub screw.

# GUNSAN