

## FANTASY-VİSAGE

### DOUBLE UPS PRİZ KULLANIM KILAVUZU / USER'S MANUAL FOR UPS TWO-GANG SOCKET

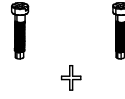

Göbek Vidası / Central Plate Screw

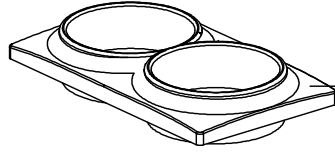

Göbek / Central Plate

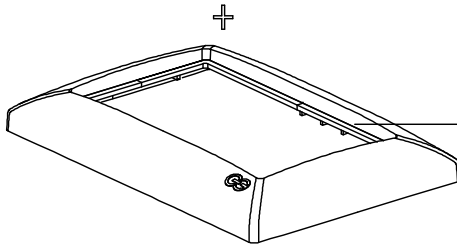

Çerçeve / Frame

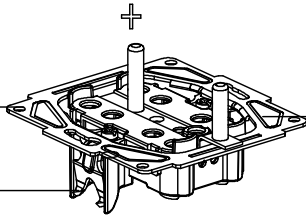

Şase / Chassis

Modül / Module

Tırnak / Claw

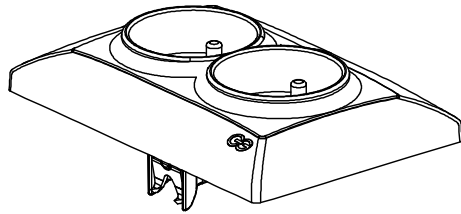

### Ürün Boyutları / Product Dimensions

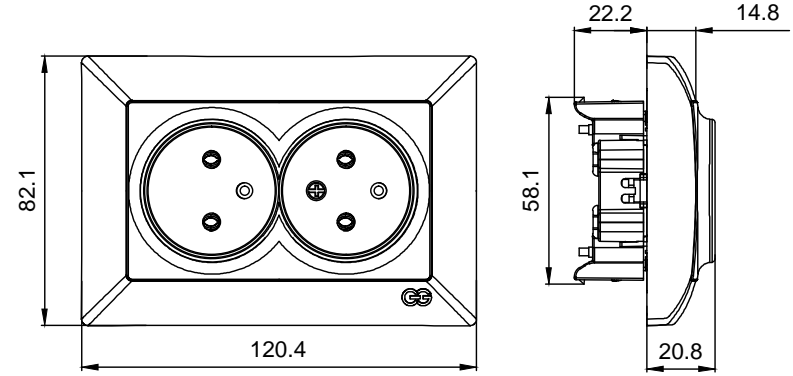

### Bağlantı Şeması / Wiring Diagram

- 16A,250V~
- İki kutuplu, Ups
- Vidalı bağlantı
- 16A,250V~
- 2 Poles, Ups
- With screw

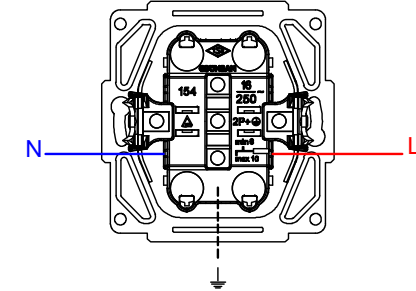

### Devre Şeması / Circuit Diagram

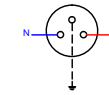

### Ürün Montajı / Product Assembly

- Kablo bağlantıları bağlantı şemasına göre yapılır.  
*Cable connections are made according to the wiring diagram.*
- Modül montaj yapılacak kasa içerisine yerleştirilip ve tırnak vidaları ile sıkıştırılarak sabitlenir.  
*The module is inserted into the enclosure and fixed by tightening with claw screws.*
- Göbek çerçeveye takılır.  
*The central plate is assembled to frame.*
- Çerçeve şasenin üzerine konumlandırılır ve göbek vidası ile sıkılarak montaj tamamlanır.  
*The frame is placed on the chassis and the assembly is completed by screwing the hub screw.*

# GUNSAN